

# SUPER X VALVOLE IN-LINEA

## Azionamenti manuali e meccanici In linea

3/2, 5/2 e 5/3, G1/8, G1/4



Ampia gamma di operatori  
Adate a flussi multidirezionali e  
per applicazioni a doppia  
pressione di alimentazione  
Forniscono elevate portate  
\*Materiali leggeri e resistenti alla  
corrosione

### DATI TECNICI

#### Fluido:

Aria compressa filtrata, lubrificata  
e non lubrificata

#### Pressione di esercizio:

Maximum 10 bar

#### Temperatura ambiente:

Dipende dal tipo di solenoide  
0°C ... +70°C

Consultare il nostro Servizio tecnico per  
applicazioni inferiori a +2°C

### MATERIALI

Corpo: lega di alluminio pressofuso

Testata terminale: alluminio o

nylon caricato vetro

Guarnizioni: gomma nitrilica

## MODELLI VALVOLE MECCANICHE

### 3/2 valvole meccaniche

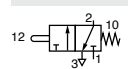
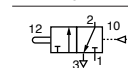
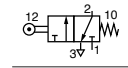
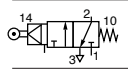
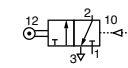
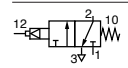
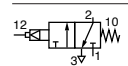
| Simbolo   | Azionamento                             | Connessione | Portata<br>(l/min) | MODELLI           |       | ACCESSORI          |                      |              | Kit ricambi |
|---|---|-------------|--------------------|-------------------|-------|--------------------|----------------------|--------------|-------------|
|   |   |             |                    | Disegno<br>no.    |       | Raccordo<br>dritto | Raccordo<br>a gomito | Silenziatore |             |
|  | Pulsante/Molla                          | G1/8        | 335                | <b>03 0400 02</b> | A, 1  | C02250618          | C02470618            | T40C1800     | 03 8408 02  |
|   | Pulsante/Molla                          | G1/4        | 965                | <b>03 0600 02</b> | B, 3  | C02250828          | C02470828            | T40C2800     | 03 8602 02  |
|  | Pulsante/Pneumatico                     | G1/8        | 335                | <b>03 0417 02</b> | C, 1  | C02250618          | C02470618            | T40C1800     | 03 8408 02  |
|   | Rotella/Molla                           | G1/8        | 335                | <b>03 0402 02</b> | A, 2  | C02250618          | C02470618            | T40C1800     | 03 8408 02  |
|  | Rotella/Molla                           | G1/4        | 965                | <b>03 0602 02</b> | B, 6  | C02250828          | C02470828            | T40C2800     | 03 8602 02  |
|   | Leva-rotella/Molla                      | G1/8        | 335                | <b>03 0411 02</b> | A, 4  | C02250618          | C02470618            | T40C1800     | 03 8408 02  |
|   | Leva-rotella/Molla                      | G1/4        | 965                | <b>03 0611 02</b> | B, 9  | C02250828          | C02470828            | T40C2800     | 03 8602 02  |
|   | Leva-rotella (servizio pesante)/Molla   | G1/8        | 335                | <b>03 0293 02</b> | A, 10 | C02250618          | C02470618            | T40C1800     | 03 8408 02  |
|  | Leva-rotella sensibile/Molla            | G1/8        | 335                | <b>03 0423 02</b> | A, 5  | C02250618          | C02470618            | T40C1800     | -           |
|   | Rotella/Pneumatico                      | G1/8        | 335                | <b>03 0409 02</b> | C, 2  | C02250618          | C02470618            | T40C1800     | 03 8408 02  |
|  | Rotella/Pneumatico                      | G1/4        | 965                | <b>03 0609 02</b> | D, 6  | C02250828          | C02470828            | T40C2800     | 03 8612 02  |
|   | Leva-rotella/Pneumatico                 | G1/8        | 335                | <b>03 0427 02</b> | C, 4  | C02250618          | C02470618            | T40C1800     | 03 8408 02  |
|  | Leva-rotella/Pneumatico                 | G1/4        | 965                | <b>03 0624 02</b> | D, 9  | C02250828          | C02470828            | T40C2800     | 03 8612 02  |
|   | Unidirezionale/Molla                    | G1/8        | 335                | <b>03 0410 02</b> | A, 7  | C02250618          | C02470618            | T40C1800     | 03 8408 02  |
|  | Unidirezionale (servizio pesante)/Molla | G1/8        | 335                | <b>03 0294 02</b> | A, 11 | C02250618          | C02470618            | T40C1800     | 03 8408 02  |
|   | Baffo/Molla                             | G1/8        | 335                | <b>03 0432 02</b> | A, 8  | C02250618          | C02470618            | T40C1800     | -           |

Per ulteriori informazioni



[www.norgren.com/info/it3-150](http://www.norgren.com/info/it3-150)

## 5/2 valvole meccaniche

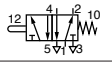
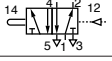
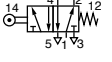
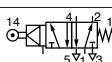
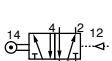
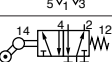
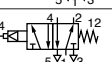
| Azionamento   | Conne-<br>ssione                        | Portata<br>(l/min) | MODELLI |                   | Disegno<br>no. | ACCESSORI          |                      |              | Kit ricambi |  |
|---|---|--------------------|---------|-------------------|----------------|--------------------|----------------------|--------------|-------------|--|
|   |   |                    |         |                   |                | Raccordo<br>dritto | Raccordo<br>a gomito | Silenziatore |             |  |
|  | Pulsante/Molla                          | G1/8               | 335     | <b>X3 0440 02</b> | E, 1           | C02250618          | C02470618            | T40C1800     | 03 8408 02  |  |
|   | Pulsante/Molla                          | G1/4               | 965     | <b>X3 0640 02</b> | F, 3           | C02250828          | C02470828            | T40C2800     | 03 8602 02  |  |
|  | Pulsante/Pneumatico                     | G1/8               | 335     | <b>X3 0457 02</b> | G, 1           | C02250618          | C02470618            | T40C1800     | 03 8408 02  |  |
|  | Rotella/Molla                           | G1/8               | 335     | <b>X3 0442 02</b> | E, 2           | C02250618          | C02470618            | T40C1800     | 03 8408 02  |  |
|   | Rotella/Molla                           | G1/4               | 965     | <b>X3 0642 02</b> | F, 6           | C02250828          | C02470828            | T40C2800     | 03 8602 02  |  |
|   | Leva-rotella/Molla                      | G1/8               | 335     | <b>X3 0451 02</b> | E, 4           | C02250618          | C02470618            | T40C1800     | 03 8408 02  |  |
|   | Leva-rotella/Molla                      | G1/4               | 965     | <b>X3 0651 02</b> | F, 9           | C02250828          | C02470828            | T40C2800     | 03 8602 02  |  |
|   | Leva-rotella (servizio pesante)/Molla   | G1/8               | 335     | <b>X3 0393 02</b> | E, 10          | C02250618          | C02470618            | T40C1800     | 03 8408 02  |  |
|  | Leva-rotella /Molla                     | G1/8               | 335     | <b>X3 0463 02</b> | E, 5           | C02250618          | C02470618            | T40C1800     | -           |  |
|   | Rotella /Pneumatico                     | G1/8               | 335     | <b>X3 0449 02</b> | G, 2           | C02250618          | C02470618            | T40C1800     | 03 8408 02  |  |
|  | Rotella /Pneumatico                     | G1/4               | 965     | <b>X3 0649 02</b> | H, 6           | C02250828          | C02470828            | T40C2800     | 03 8612 02  |  |
|   | Leva-rotella/Pneumatico                 | G1/8               | 335     | <b>X3 0467 02</b> | G, 4           | C02250618          | C02470618            | T40C1800     | 03 8408 02  |  |
|   | Leva-rotella/Pneumatico                 | G1/4               | 965     | <b>X3 0664 02</b> | H, 9           | C02250828          | C02470828            | T40C2800     | 03 8612 02  |  |
|   | Unidirezionale/Molla                    | G1/8               | 335     | <b>X3 0450 02</b> | E, 7           | C02250618          | C02470618            | T40C1800     | 03 8408 02  |  |
|  | Unidirezionale (servizio pesante)/Molla | G1/8               | 335     | <b>X3 0394 02</b> | E, 11          | C02250618          | C02470618            | T40C1800     | 03 8408 02  |  |
|  | Baffo/Molla                             | G1/8               | 335     | <b>X3 0472 02</b> | E, 8           | C02250618          | C02470618            | T40C1800     | -           |  |

## MODELLI VALVOLE MANUALI



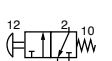
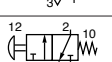
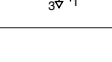
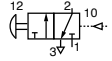
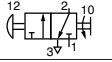
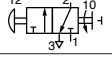
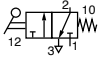
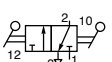
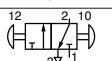
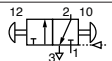
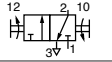
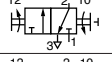
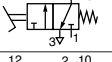



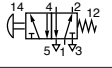
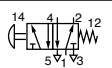
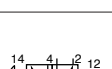
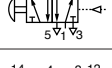
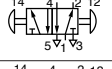
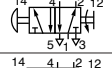
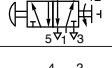

### 3/2 valvole manuali

| Azionamento   | Conne-<br>ssione                  | Portata<br>(l/min) | Colore | MODELLI |                       | Disegno<br>no. | ACCESSORI          |                      |              | Kit ricambi |  |
|---|-----------------------------------|--------------------|--------|---------|-----------------------|----------------|--------------------|----------------------|--------------|-------------|--|
|   |                                   |                    |        |         |                       |                | Raccordo<br>dritto | Raccordo<br>a gomito | Silenziatore |             |  |
|  | Pulsante/molla                    | G1/8               | 335    | Nero    | <b>03 0404 02</b>     | A, 12          | C02250618          | C02470618            | T40C1800     | 03 8408 02  |  |
|   | Pulsante/molla                    | G1/4               | 965    | Nero    | <b>03 0604 02</b>     | B, 14          | C02250828          | C02470828            | T40C2800     | 03 8602 02  |  |
|   | Pulsante/molla                    | G1/8               | 335    | Verde   | <b>03 0405 02</b>     | A, 12          | C02250618          | C02470618            | T40C1800     | 03 8408 02  |  |
|   | Pulsante/molla                    | G1/8               | 335    | Rosso   | <b>03 0406 02</b>     | A, 12          | C02250618          | C02470618            | T40C1800     | 03 8408 02  |  |
|   | Pulsante (palmere)/molla          | G1/8               | 335    | Rosso   | <b>03 0366 02</b>     | A, 15          | C02250618          | C02470618            | T40C1800     | 03 8408 02  |  |
|   | Pulsante (palmere)/molla          | G1/8               | 335    | Verde   | <b>03 0367 02</b>     | A, 15          | C02250618          | C02470618            | T40C1800     | 03 8408 02  |  |
|  | Pulsante (palmere)/molla          | G1/8               | 335    | Nero    | <b>03 0368 02</b>     | A, 15          | C02250618          | C02470618            | T40C1800     | 03 8408 02  |  |
|   | Pulsante (protetto)/molla         | G1/8               | 335    | Nero    | <b>03 0414 02</b>     | A, 13          | C02250618          | C02470618            | T40C1800     | 03 8408 02  |  |
|   | Pulsante (protetto)/molla         | G1/8               | 335    | Verde   | <b>03 0415 02</b>     | A, 13          | C02250618          | C02470618            | T40C1800     | 03 8408 02  |  |
|  | Pulsante (protetto)/molla         | G1/8               | 335    | Rosso   | <b>03 0416 02</b>     | A, 13          | C02250618          | C02470618            | T40C1800     | 03 8408 02  |  |
|   | Pulsante/Pneumatico               | G1/8               | 335    | Nero    | <b>03 0408 02</b>     | C, 12          | C02250618          | C02470618            | T40C1800     | 03 8408 02  |  |
|   | Pulsante/Pneumatico               | G1/4               | 965    | Nero    | <b>03 0608 02</b>     | D, 14          | C02250828          | C02470828            | T40C2800     | 03 8612 02  |  |
|   | Pulsante/Pneumatico               | G1/8               | 335    | Verde   | <b>03 0420 02</b>     | C, 12          | C02250618          | C02470618            | T40C1800     | 03 8408 02  |  |
|  | Pulsante/Pneumatico               | G1/8               | 335    | Rosso   | <b>03 0421 02</b>     | C, 12          | C02250618          | C02470618            | T40C1800     | 03 8408 02  |  |
|   | Stop di emergenza/ rotante        | G1/8               | 335    | Rosso   | <b>03 0299 02</b>     | A, 16          | C02250618          | C02470618            | T40C1800     | 03 8473 02  |  |
|  | Pulsante, palmere/chiave          | G1/8               | 335    | Rosso   | <b>03 0335 02</b>     | A, 17          | C02250618          | C02470618            | T40C1800     | 03 8408 02  |  |
|  | Leva/molla                        | G1/8               | 335    | Nero    | <b>03 0438 02</b>     | A, 23          | C02250618          | C02470618            | T40C1800     | 03 8408 02  |  |
|   | Leva/molla                        | G1/4               | 965    | Nero    | <b>03 0638 02</b>     | B, 31          | C02250828          | C02470828            | T40C2800     | 03 8602 02  |  |
|   | Leva manopola/molla               | G1/8               | 335    | Nero    | <b>03 0426 02</b>     | A, 19          | C02250618          | C02470618            | T40C1800     | 03 8408 02  |  |
|  | Toggle/toggle                     | G1/8               | 335    | Nero    | <b>03 0403 02</b>     | A, 22          | C02250618          | C02470618            | T40C1800     | 03 8408 02  |  |
|   | Leva/Leva                         | G1/8               | 335    | Nero    | <b>03 0437 02</b>     | A, 23          | C02250618          | C02470618            | T40C1800     | 03 8408 02  |  |
|   | Leva/Leva                         | G1/4               | 965    | Nero    | <b>03 0637 02</b>     | B, 31          | C02250828          | C02470828            | T40C2800     | 03 8602 02  |  |
|  | Manopola/Manopola                 | G1/8               | 335    | Nero    | <b>03 0425 02</b>     | A, 21          | C02250618          | C02470618            | T40C1800     | 03 8408 02  |  |
|   | Manopola/Manopola                 | G1/4               | 965    | Nero    | <b>03 0625 02</b>     | B, 20          | C02250828          | C02470828            | T40C2800     | 03 8602 02  |  |
|  | Manopola/Manopola o pilotaggio    | G1/8               | 335    | Nero    | <b>03 0424 02</b>     | D, 21          | C02250618          | C02470618            | T40C1800     | 03 8408 02  |  |
|   | Manopola/Manopola o pilotaggio    | G1/4               | 965    | Nero    | <b>03 0627 02</b>     | D, 20          | C02250828          | C02470828            | T40C2800     | 03 8612 02  |  |
|  | Manopola rotante/manopola rotante | G1/8               | 335    | Nero    | <b>03 0298 02</b>     | A, 27          | C02250618          | C02470618            | T40C1800     | 03 8408 02  |  |
|  | Chiave/chiave                     | G1/8               | 335    | Chrome  | <b>03 0418 02 801</b> | A, 28          | C02250618          | C02470618            | T40C1800     | 03 8408 02  |  |
|   | Pedale/molla                      | G1/8               | 335    | Nero    | <b>03 0481 02</b>     | 29             | C02250618          | C02470618            | T40C1800     | 03 8408 02  |  |
|  | Pedale/molla                      | G1/4               | 965    | Nero    | <b>03 0681 02</b>     | 29             | C02250828          | C02470828            | T40C2800     | 03 8602 02  |  |
|   | Pedale/ Pedale                    | G1/8               | 335    | Nero    | <b>03 0483 02</b>     | 29             | C02250618          | C02470618            | T40C1800     | 03 8408 02  |  |
|  | Pedale/ Pedale                    | G1/4               | 965    | Nero    | <b>03 0683 02</b>     | 29             | C02250828          | C02470828            | T40C2800     | 03 8602 02  |  |

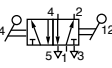
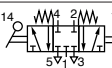
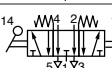
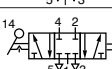
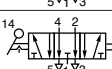
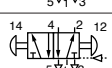
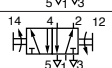
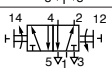
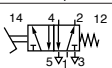
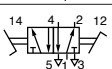
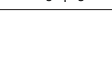
# SUPER X VALVOLE IN-LINEA Azionamenti manuali e meccanici

3/2, 5/2 e 5/3, G1/8, G1/4

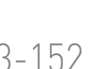
## 5/2 e 5/3 valvole manuali

| Azionamento   | Mid pos. | Conne-<br>ssione | Portata<br>(l/min) | Colore | MODELLI               | Disegno<br>no. | ACCESSORI          |                      |              | Kit ricambi |
|---|----------|------------------|--------------------|--------|-----------------------|----------------|--------------------|----------------------|--------------|-------------|
|   |          |                  |                    |        |                       |                | Raccordo<br>dritto | Raccordo a<br>gomito | Silenziatore |             |
| Pulsante/molla  | -        | G1/8             | 335                | Nero   | <b>X3 0444 02</b>     | E, 12          | C02250618          | C02470618            | T40C1800     | 03 8408 02  |
| Pulsante/molla  | -        | G1/4             | 965                | Nero   | <b>X3 0644 02</b>     | F, 14          | C02250828          | C02470828            | T40C2800     | 03 8602 02  |
| Pulsante/molla  | -        | G1/8             | 335                | Verde  | <b>X3 0445 02</b>     | E, 12          | C02250618          | C02470618            | T40C1800     | 03 8408 02  |
| Pulsante/molla  | -        | G1/8             | 335                | Rosso  | <b>X3 0446 02</b>     | E, 12          | C02250618          | C02470618            | T40C1800     | 03 8408 02  |
|  Pulsante (palmere)/molla                | -        | G1/8             | 335                | Rosso  | <b>X3 0386 02</b>     | E, 15          | C02250618          | C02470618            | T40C1800     | 03 8408 02  |
|  Pulsante (palmere)/molla                | -        | G1/8             | 335                | Verde  | <b>X3 0387 02</b>     | E, 15          | C02250618          | C02470618            | T40C1800     | 03 8408 02  |
|  Pulsante (palmere)/molla                | -        | G1/8             | 335                | Nero   | <b>X3 0388 02</b>     | E, 15          | C02250618          | C02470618            | T40C1800     | 03 8408 02  |
|  Pulsante (protetto)/molla               | -        | G1/8             | 335                | Nero   | <b>X3 0454 02</b>     | E, 13          | C02250618          | C02470618            | T40C1800     | 03 8408 02  |
|  Pulsante (protetto)/molla               | -        | G1/8             | 335                | Verde  | <b>X3 0455 02</b>     | E, 13          | C02250618          | C02470618            | T40C1800     | 03 8408 02  |
|  Pulsante (protetto)/molla              | -        | G1/8             | 335                | Rosso  | <b>X3 0456 02</b>     | E, 13          | C02250618          | C02470618            | T40C1800     | 03 8408 02  |
| Pulsante/Pneumatico   | -        | G1/8             | 335                | Nero   | <b>X3 0448 02</b>     | G, 12          | C02250618          | C02470618            | T40C1800     | 03 8408 02  |
|  Pulsante/Pneumatico                   | -        | G1/4             | 965                | Nero   | <b>X3 0648 02</b>     | H, 14          | C02250828          | C02470828            | T40C2800     | 03 8612 02  |
|  Pulsante/Pneumatico                   | -        | G1/8             | 335                | Verde  | <b>X3 0460 02</b>     | G, 12          | C02250618          | C02470618            | T40C1800     | 03 8408 02  |
|  Pulsante/Pneumatico                   | -        | G1/8             | 335                | Rosso  | <b>X3 0461 02</b>     | G, 12          | C02250618          | C02470618            | T40C1800     | 03 8408 02  |
|  Manopola push/Manopola pull           | -        | G1/8             | 335                | Nero   | <b>X3 0465 02</b>     | E, 26          | C02250618          | C02470618            | T40C1800     | 03 8408 02  |
|  Manopola/Manopola                     | -        | G1/4             | 965                | Nero   | <b>X3 0665 02</b>     | M, 20          | C02250828          | C02470828            | T40C2800     | 03 8602 02  |
|  Stop di emergenza/ rotante            | -        | G1/8             | 335                | Rosso  | <b>X3 0299 02</b>     | E, 16          | C02250618          | C02470618            | T40C1800     | 03 8473 02  |
|  Palm Button, push/Key                 | -        | G1/8             | 335                | Rosso  | <b>X3 0375 02 801</b> | E, 17          | C02250618          | C02470618            | T40C1800     | 03 8408 02  |
|  Leva/molla                            | -        | G1/8             | 335                | Nero   | <b>X3 0478 02</b>     | E, 22          | C02250618          | C02470618            | T40C1800     | 03 8408 02  |
|  Leva/molla                            | -        | G1/4             | 965                | Nero   | <b>X3 0678 02</b>     | F, 31          | C02250828          | C02470828            | T40C2800     | 03 8602 02  |
|  Leva manopola/molla                   | -        | G1/8             | 335                | Nero   | <b>X3 0466 02</b>     | E, 19          | C02250618          | C02470618            | T40C1800     | 03 8408 02  |
|  Toggle/toggle                         | -        | G1/8             | 335                | Nero   | <b>X3 0443 02</b>     | E, 24          | C02250618          | C02470618            | T40C1800     | 03 8408 02  |
|  Leva/leva                             | -        | G1/8             | 335                | Nero   | <b>X3 0477 02</b>     | E, 23          | C02250618          | C02470618            | T40C1800     | 03 8408 02  |
|  Leva/leva                             | -        | G1/4             | 965                | Nero   | <b>X3 0677 02</b>     | F, 31          | C02250828          | C02470828            | T40C2800     | 03 8602 02  |
|  Leva/molla/Leva                       | APB      | G1/8             | 335                | Nero   | <b>X3 3438 02</b>     | J, 32          | C02250618          | C02470618            | T40C1800     | 03 8408 02  |
|  Leva/molla/Leva                       | APB      | G1/4             | 965                | Nero   | <b>X3 3638 02</b>     | J, 32          | C02250828          | C02470828            | T40C2800     | 03 8602 02  |
|  Leva/molla/Leva                       | COE      | G1/8             | 335                | Nero   | <b>X3 3478 02</b>     | J, 32          | C02250618          | C02470618            | T40C1800     | 03 8408 02  |
|  Leva/molla/Leva                       | COE      | G1/4             | 965                | Nero   | <b>X3 3678 02</b>     | J, 32          | C02250828          | C02470828            | T40C2800     | 03 8602 02  |
|  Leva/leva/Leva                        | APB      | G1/8             | 335                | Nero   | <b>X3 3437 02</b>     | J, 32          | C02250618          | C02470618            | T40C1800     | 03 8408 02  |
|  Leva/leva/Leva                        | APB      | G1/4             | 965                | Nero   | <b>X3 3637 02</b>     | J, 32          | C02250828          | C02470828            | T40C2800     | 03 8602 02  |
|  Leva/leva/Leva                        | COE      | G1/8             | 335                | Nero   | <b>X3 3477 02</b>     | J, 32          | C02250618          | C02470618            | T40C1800     | 03 8408 02  |
|  Leva/leva/Leva                        | COE      | G1/4             | 965                | Nero   | <b>X3 3677 02</b>     | J, 32          | C02250828          | C02470828            | T40C2800     | 03 8602 02  |
|  Manopola/Manopola<br>o Pneumatico     | -        | G1/8             | 335                | Nero   | <b>X3 0464 02</b>     | G, 21          | C02250618          | C02470618            | T40C1800     | 03 8408 02  |
|  Manopola rotante/<br>manopola rotante | -        | G1/8             | 335                | Nero   | <b>X3 0298 02</b>     | E, 27          | C02250618          | C02470618            | T40C1800     | 03 8408 02  |
|  Chiave/chiave                         | -        | G1/8             | 335                | Chrome | <b>X3 0458 02 801</b> | E, 28          | C02250618          | C02470618            | T40C1800     | 03 8408 02  |
|  Pedale/molla                          | -        | G1/8             | 335                | Nero   | <b>X3 0482 02</b>     | 29             | C02250618          | C02470618            | T40C1800     | 03 8408 02  |
|  Pedale/molla                          | -        | G1/4             | 965                | Nero   | <b>X3 0682 02</b>     | 29             | C02250828          | C02470828            | T40C2800     | 03 8602 02  |
|  Pedale/ Pedale                        | -        | G1/8             | 335                | Nero   | <b>X3 0484 02</b>     | 29             | C02250618          | C02470618            | T40C1800     | 03 8408 02  |
|  Pedale/ Pedale                        | -        | G1/4             | 965                | Nero   | <b>X3 0684 02</b>     | 29             | C02250828          | C02470828            | T40C2800     | 03 8602 02  |

## DIMENSIONI

G1/8, 3/2 ritorno molla, corpo base

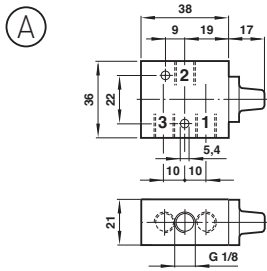

G1/4, 3/2 ritorno molla, corpo base

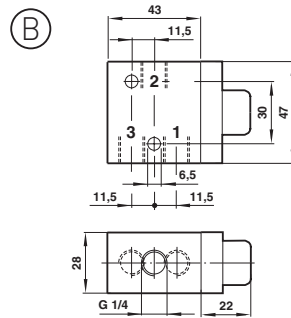

G1/8, 3/2 ritorno pneumatico, corpo base

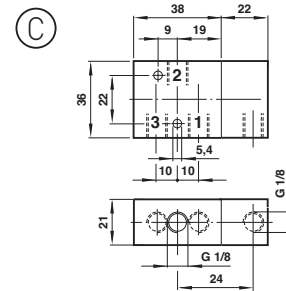

G1/4, 3/2 ritorno pneumatico, corpo base

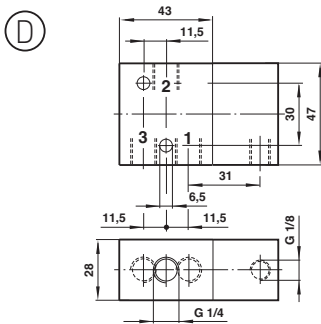

G1/8, 5/2 ritorno pneumatico, corpo base

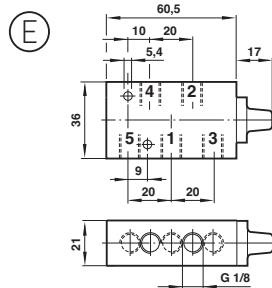

G1/4, 5/2 ritorno molla, corpo base

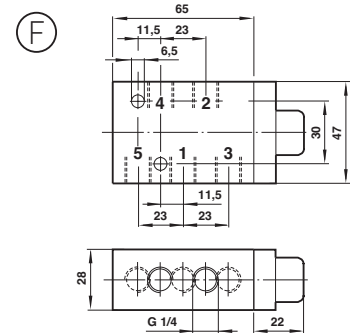

G1/8, 5/2 ritorno pneumatico, corpo base

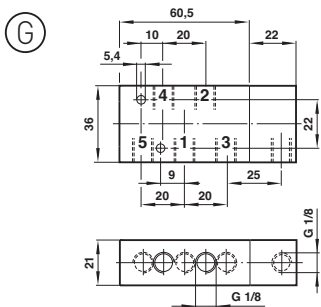

G1/4, 5/2 ritorno pneumatico, corpo base

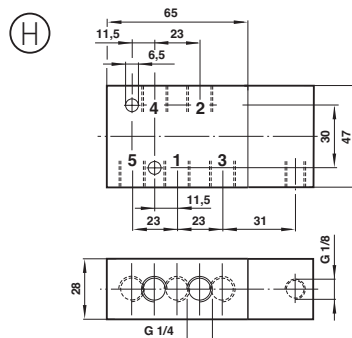

G1/4, 5/3 ritorno molla, corpo base

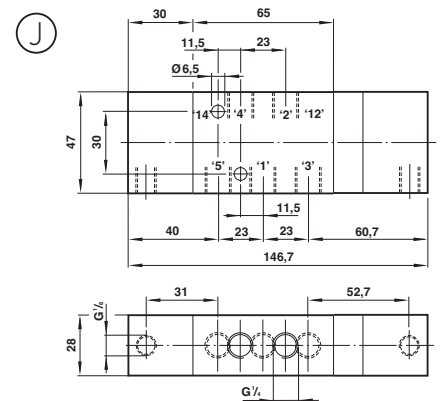

# SUPER X VALVOLE IN-LINEA Azionamenti manuali e meccanici

3/2, 5/2 e 5/3, G1/8, G1/4

## Azionamenti meccanici

Pulsante - G1/8 valvole

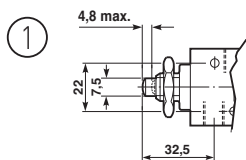

Rotella - G1/8 valvole

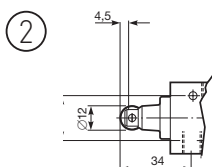

Pulsante - G1/4 valvole

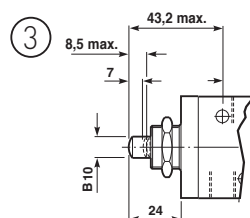

Leva-rotella - G1/8 valvole

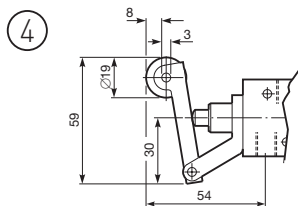

Leva-rotella sensibile - G1/8 valvole

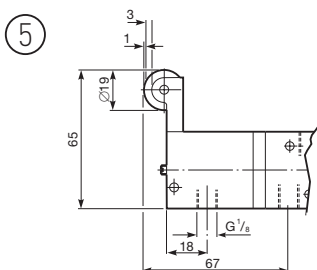

Rotella - G1/4 valvole

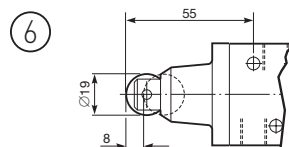

Unidirezionale - G1/8 valvole

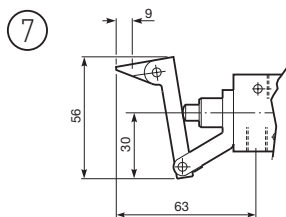

Baffo - G1/8 valvole

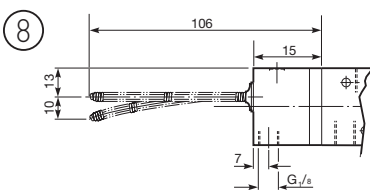

Leva-rotella - G1/4 valvole

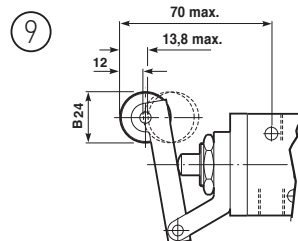

Leva-rotella per servizio pesante - G1/8 valvole

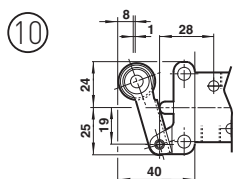

Impieghi pesanti - unidirezionale - G1/8 valvole

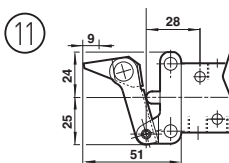

## Attuatori manuali

Pulsante – G1/8 valvole

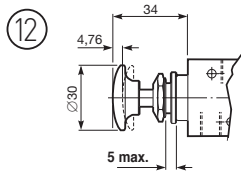

Pulsante (protetto) – G1/8 valvole

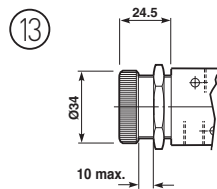

Pulsante – G1/4 valvole

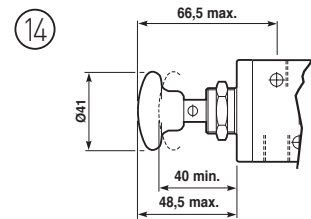

Pulsante (palmere)– G1/8 valvole

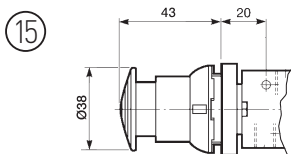

Stop di emergenza– G1/8 valvole

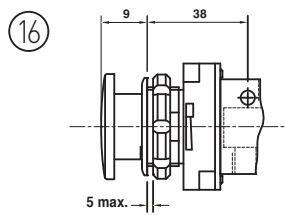

Pulsante/chiave – G1/8 valvole

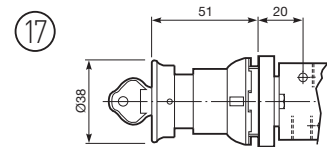

Leva/manopola – G1/8 valvole

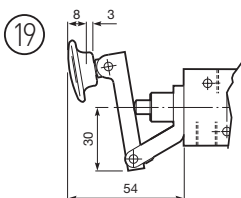

Knob – G1/4 valvole

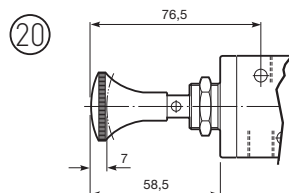

Knob – G1/8 valvole

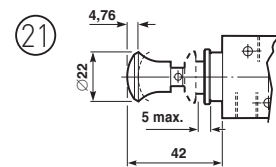

# SUPER X VALVOLE IN-LINEA Azionamenti manuali e meccanici

3/2, 5/2 e 5/3, G1/8, G1/4

Valvola con azionamento a leva e ritorno a molla – G1/8 valvole

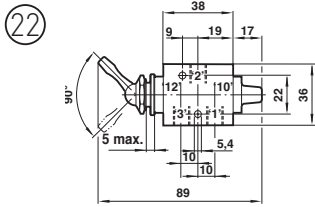

Valvola con azionamento a leva e ritorno a molla – G1/8 valvole

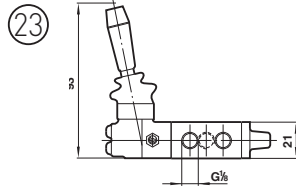

Interruttore – G1/8 valvole

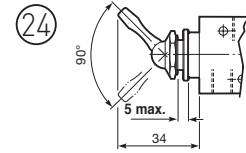

Valvola con azionamento a leva e ritorno a molla – G1/8 valvole

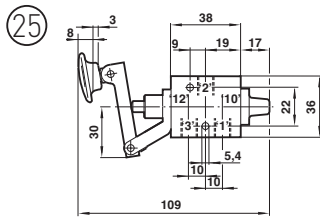

Valvola azionata a manopola con ritorno manopola – G1/8 valvole

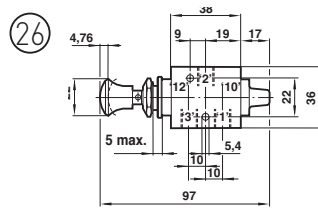

Manopola rotante – G1/8 valvole

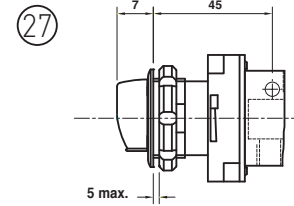

chiave – G1/8 valvole

